

equipments
and supplies

2024

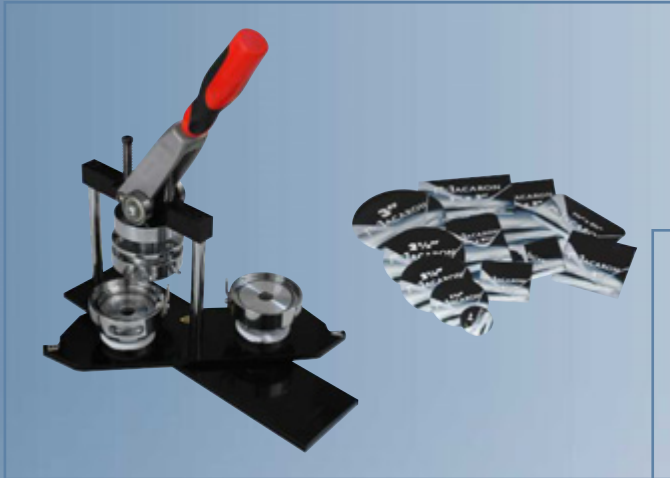

MACARON

www.macaron.ca

A true value since 1981

Prices are in Canadian dollars and are subject to change without notice. Taxes will be added if applicable.

Payment terms: Net 30 days upon credit approval, accounts that are overdue, will be charged interest. Pre-payment is required on first order. We accept Visa and Master Card.

Shipping: F.O.B. Montreal Quebec, if merchandise is in stock, shipping will be on the same day (order has to be given before 2h00 PM, eastern time). Back orders, shipping will be communicated to you with reception of order.

All orders will be shipped via Purolator prepaid and charge to your invoice. If you want the use of another carrier (collect), please advise on your purchase order. We are not responsible for delays due to the transport company.

Shipping third parties: Supply us with packing slips and stickers.

Cancellation: On custom products, no cancellation will be taken after order reception. After that date, a written request is required, and any work that has been done will be billed at an accumulated cost.

Return: Stock and non-custom products can be returned within 10 days of reception. 20% of re-stocking will be applied. Please call to get approval on return. Shipping cost will not be credited, and goods must be shipped pre-paid. Custom made goods are not returnable.

Warranty: Our equipment is covered by this following warranty: a three months guarantee on parts and labours.

Service and repairs: Call us for assistance, if your equipment requires factory service. Repairs will be made in our Montreal plant.

Trademarks: Any products and logos printed in this catalogue appear only to illustrate the basic products and ability to include messages and art. They do not imply any endorsement, nor is any item with the specific logos for sale to anyone other than the parties expressly authorized by or for the trademark owners.

Supplied logos will be accepted as being legal in all regards to the various trademark and copyright laws. The factory bears no responsibility for legal infringements and will not be held responsible for any infringements of these laws. It is assumed that the clients have obtained all due permission of reproduction of these logos and trademarks.

Macaron reserves the right to modify prices, without any notice.

Prices effective as of October 2023.

**TELEPHONE: 514.721.5221
1.800.350.4383**

**FAX: 514.722.7099
1.800.465.6424**

Acrylic key tags	8
Badge magnets	23
Binding equipment & supplies	14
Button machines	4-5
Button parts	6-7
Convention badge holders	16-20
Cutting mats	30
Guillotines	28
Heavy duty cutters	29
Hot stamping presses & supplies	31
Key rings	23
Laminating films	9
Laminating pouches	10-11
Lanyard & beaded chains	24-25
Luggage straps	21
Office laminators	11
Pins & attachments	22
Retractable badge reels	26
Rounder corner machine	12
Ruler "Safety edge"	30
Scissors	30
Self-adhesive magnetic sheet	8
Sharpeners	30
Shrink wrap machine & supplies	15
Slot punch and other shape	13
Trimmers	27
Wrist band	26

macaron@macaron.ca
www.macaron.ca

VISIT
www.promomacaron.ca
FOR ALL OUR
PROMOTIONAL PRODUCTS

Buttons machine, eyelets press & key tags
Page 4



Laminating film
Page 9



Laminating equipment
Page 10



Rounded corner machine and slot punch
Page 12



Shrink wrap machine
Page 15



Manual shredder, binding machines & supplies
Page 16



Badge holders
Page 17



Luggage straps
Page 21



I.d. Attachments & pins
Page 22



Cords, lanyards, retractable badge reels and wristbands
Page 23

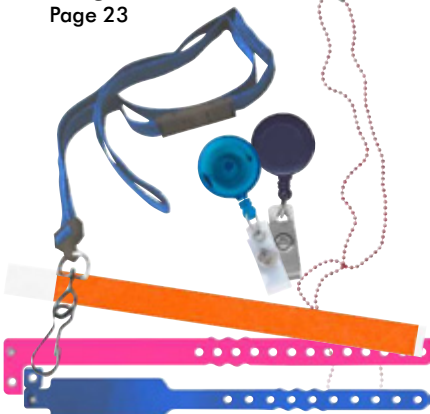

Dahle cutting products
Page 27



Hot stamping
Page 31





Macaron has been manufacturing the manual button machine since 1981. It produces from 200 to 300 buttons/per hour and required no technical expertise. It is easy as 1,2,3...



Round 3"	
Item	423000
Format	Round 3"
Weight	29 lb
Cutter	Top mounted cutter
Size	10-3/4" x 15" x 8-1/4"
Price	890.00



Square 1-1/2" X 1-1/2"	
Item	423412
Format	Square 1-1/2" X 1-1/2"
Weight	30 lb
Cutter	Separate punch cutter
Size	10" x 13" x 7"
Price	1505.00



**Compatible with
button dies**
(See on page 5)

EYELET PRESS

With interchangeable dies available in 10mm, 14mm and 17mm Press sold with 1 adaptor and 1 size die only.

Item	420999	285.00
------	--------	--------



EYELETS WITH WASHERS

Eyelets are available in 10mm, 14mm and 17mm (pack in 1000 pcs)

Item	Description	Unit price
431010	10mm eyelet	0.079
431014	14mm eyelet	0.079
431017	17mm eyelet	0.079



EYELET DIES

Dies are available in 10mm, 14mm and 17mm

Item	Description	Unit price
425100	Die adaptor (to convert your button press to eyelet)	40.30
425110	10mm eyelet die with punch	88.00
425114	14mm eyelet die with punch	88.00
425117	17mm eyelet die with punch	88.00



BUTTON MACHINE
SWINGING TABLE for an
optimal production speed.

New model with
interchangeable dies
Weight: 17 lb
Included: choice of 1 size of dies

Item	420900	432.00
------	--------	--------



Extra dies available

Item	Size	Price
421000D	1" (25mm)	205.10
421250D	1-1/4" (32mm)	205.10
421500D	1-1/2" (37mm)	205.10
421750D	1-3/4" (44mm)	205.10
422250D	2-1/4" (56mm)	213.15
422500D	2-1/2" (65mm)	213.15

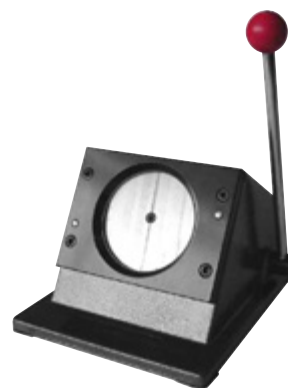

TABLE TOP PAPER CUTTER
FOR BUTTON MACHINE

Weight: 5 lb

Item	Size	Price
421000CUT	1" (25mm)	118.00
421250CUT	1-1/4" (32mm)	118.00
421500CUT	1-1/2" (37mm)	118.00
421750CUT	1-3/4" (44mm)	146.50
422250CUT	2-1/4" (56mm)	170.50
422500CUT	2-1/2" (65mm)	181.50

MULTI-SHEET CUTTER

Specifications:

- 1) Materials: high quality steel
- 2) Changeable cutting board for button paper
- 3) Can cut multiple sheets of paper at once
- 4) Easy to operate, suitable for bulk productions
- 5) Included: a choice of 1 cutting board

Weight: 25 lb

Item	421999	350.00
------	--------	--------

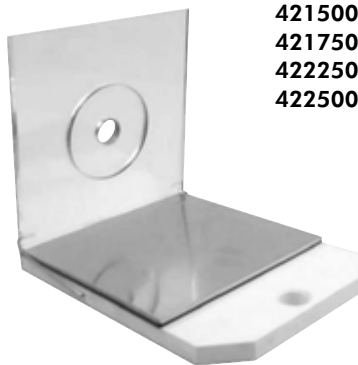
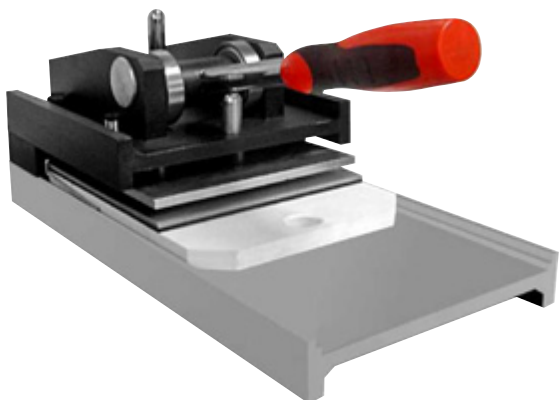

Extra cutting board

Item	Size	Price
421000MC	1" (25mm)	87.70
421250MC	1-1/4" (32mm)	87.70
421500MC	1-1/2" (37mm)	87.70
421750MC	1-3/4" (44mm)	87.70
422250MC	2-1/4" (56mm)	87.70
422500MC	2-1/2" (65mm)	87.70

Button parts are sold with front, plastic and back with pin already installed.
Packaging: box 1000 units only.

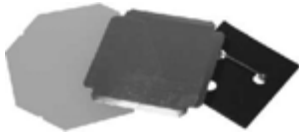

Round		UNIT PRICE				
Item	Format	1000	2000	5000	10000	Weight/1000
431100	1" (25mm)	0.142	0.138	0.134	0.130	5 lb
431125	1-1/4" (32mm)	0.146	0.142	0.138	0.133	8 lb
431150	1-1/2" (37mm)	0.152	0.148	0.143	0.139	10 lb
431175	1-3/4" (44mm)	0.157	0.153	0.148	0.143	17 lb
431225	2-1/4" (56mm)	0.195	0.190	0.184	0.178	30 lb
431250	2-1/2" (65mm)	0.199	0.194	0.188	0.182	38 lb
431300	3" (77mm)	0.254	0.247	0.239	0.232	42 lb

Square		UNIT PRICE				
Item	Format	1000	2000	5000	10000	Weight/1000
431411	1-1/2" X 1-1/2"	0.223	0.217	0.210	0.203	16 lb
431412	1-1/2" X 1-1/2" diag.	0.223	0.217	0.210	0.203	16 lb

ASSEMBLY SERVICE

Supply us with your printed material* and we will assemble the buttons for you.

Contact us for an estimate

* Ask for specifications or visit our website www.macaron.ca for specifications



SPECIAL BUTTON PARTS

Magnets, mirror and key holder can replace the back pin. The price includes all parts (front, back, plastic and the special part). Sold per box of 100 units only.

Mirror button parts (front, plastic, ring, mirror & spring)

						UNIT PRICE
Item	Format	100	500	1000	5000	Weight/1000
431225MR	2-1/4" (56mm) round	0.503	0.455	0.411	0.387	56 lb
431250MR	2-1/2" (65mm) round	0.559	0.505	0.457	0.430	60 lb
435251	vinyl pouch black	0.239	0.213	0.193	0.175	10 lb

Key holder button parts (front, plastic, flat back & chain with key ring)

						UNIT PRICE
Item	Format	100	500	1000	5000	Weight/1000
431100KH	1" (25mm) round	0.418	0.378	0.342	0.322	15 lb
431125KH	1-1/4" (32mm) round	0.424	0.383	0.346	0.326	22 lb
431150KH	1-1/2" (37mm) round	0.330	0.298	0.269	0.253	17 lb
431175KH	1-3/4" (44mm) round	0.335	0.303	0.274	0.258	24 lb

Bottle-opener with magnet button parts

						UNIT PRICE
Item	Format	100	500	1000	5000	Weight/1000
431225BO	2-1/4" (56mm) round	0.651	0.589	0.533	0.502	84 lb
431250BO	2-1/2" (65mm) round	0.721	0.652	0.590	0.555	90 lb

Paper clip button parts 1" (25mm)

						UNIT PRICE
Item	Format	100	500	1000	5000	Weight/1000
431100CL	Paper clip	0.279	0.214	0.164	0.163	6 lb

Thumbtack magnetic parts

						UNIT PRICE
Item	Format	100	500	1000	5000	Weight/1000
431100TT	1" (25mm) round	0.502	0.454	0.410	0.386	9 lb
431125TT	1-1/4" (32mm) round	0.552	0.499	0.451	0.424	11 lb

Shoe laces charm parts 1" (25mm)

						UNIT PRICE
Item	Format	100	500	1000	5000	Weight/1000
431100SL	Shoe lace charm	0.168	0.152	0.137	0.129	6 lb

"Finger grip" parts 1-1/4" (32mm)

						UNIT PRICE
Item	Format	100	500	1000	5000	Weight/1000
431125FG	"Finger grip"	0.693	0.627	0.567	0.533	22 lb

Pen for button parts 1" (25mm) (button parts 1" (25mm) included)

						UNIT PRICE
Item	Format	100	500	1000	5000	Weight/1000
430PENXX	Pen (white,pink,green or aqua)	0.427	0.386	0.349	0.329	8 lb

Magnet button parts

						UNIT PRICE
Item	Format	100	500	1000	5000	Weight/1000
431176	1-3/4" (44mm) round	0.376	0.289	0.222	0.209	20 lb
431251	2-1/2" (65mm) round	0.448	0.344	0.264	0.249	40 lb

Strong Magnet button parts

						UNIT PRICE
Item	Format	100	500	1000	5000	Weight/1000
431100MAG	1" (25mm) round (strong magnet)	0.418	0.378	0.342	0.322	8 lb
431125MAG	1-1/4" (32mm) round (strong magnet)	0.424	0.383	0.346	0.326	12 lb
431150MAG	1-1/2" (37mm) round (strong magnet)	0.434	0.392	0.355	0.334	15 lb
431175MAG	1-3/4" (44mm) round (strong magnet)	0.449	0.406	0.367	0.345	23 lb
431225MAG	2-1/4" (56mm) round (strong magnet)	0.503	0.455	0.411	0.387	27 lb
431250MAG	2-1/2" (65mm) round (strong magnet)	0.559	0.505	0.457	0.430	40 lb
431100SAF	Magnet clothes protector	0.720	0.642	0.583	0.530	10 lb

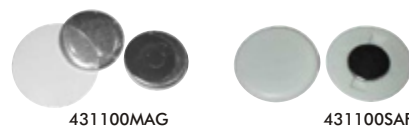
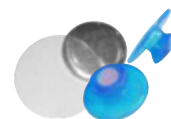

ACRYLIC KEY TAGS, FRIDGE MAGNET AND COASTER

To insert pictures, artwork, photocopies. No tools are required thanks to the snap cover. Key tags are sold blank. Sold in pack of 120.

NEW!
Coaster

NEW!
Fridge magnet



Item: 631055
Square, coaster
Insert size:
3 1/2" x 3 1/2"
Weight: 12 lb /120



Item: 631040
Square, magnetic back
Insert size:
2 1/4" x 2 1/4"
Weight: 9 lb /120



Item: 631044
Format: Rectangular
Insert size:
1 3/4" x 2 3/4"
Weight: 9 lb /120



Item: 631048
Rectangular, magnetic back
Insert size:
1 3/4" x 2 3/4"
Weight: 9 lb /120



Item: 632026
Format: Rectangular
Insert size:
1 1/16" x 1 3/4"
Weight: 4.5 lb /120



Item: 632030
Format: Rectangular
Insert size:
1 3/16" x 1 5/8"
Weight: 5.5 lb /120



Item: 632035
Format: Square
Insert size:
1 3/8" x 1 3/8"
Weight: 5 lb /120



Item: 632042
Format: Round
Insert size:
1 3/8"
Weight: 4.5 lb /120

Item	Unit Price						
	120	240	720	960	1920	4800	
632026-632030-632035-632042	0.827	0.794	0.763	0.732	0.698	0.663	
631040-631044-631048	0.996	0.957	0.918	0.882	0.840	0.798	
631055	1.251	1.201	1.153	1.107	1.055	1.003	

SELF ADHESIVE MAGNETIC SHEET

The magnetic sheet enables you to display pictures, business cards, certificates, on refrigerators, file cabinets, school lockers or any metal surface. The sheet can be cut with the help of the die cutting press (see above item) trimmer or scissors, then simply remove the covering and apply the chosen photo or print.

Item	Pack Per	Sheet Size	Weight	Unit Price
434001	100	1/2" X 1"	0.37 lb	0.10
434003	50	2" X 3-1/2"	0.93 lb	0.48
434006	25	4" X 6"	2 lb	1.60
434011	10	8-1/2" X 11"	3.3 lb	5.65
434017	5	11" X 17"	3.25 lb	10.75
434024	1	24" X 24"	2 lb	29.80
434050	1	Full Roll 24" X 50'	48 lb	548.00

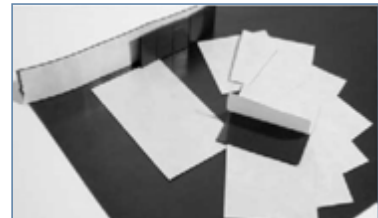

ADJUSTABLE CIRCLE CUTTER

This cutter enables you to cut from 2" to 6". Sold with a replacement blade.

Item	Weight	Unit Price
433926	0.21 lb	40.90



Laminating films are available in 1.5, 3.0, 5.0 and 10 mil in 1" core. Made of first grade material, this tough transparent film provides protection with a penetrating and permanent bond. Available in clear or matt finishes.

UNIT PRICE

1" Core	2-1/4" Core	DESCRIPTION	2-4	6-10	12-18	20+	lb/roll
512109	513109	FILM 1.5 MIL x 9 " x 500 ' CLEAR	21.30	20.25	19.20	18.15	4.0
512112	513112	FILM 1.5 MIL x 12 " x 500 ' CLEAR	28.35	26.95	25.55	24.10	5.5
512118	513118	FILM 1.5 MIL x 18 " x 500 ' CLEAR	42.55	40.45	38.30	36.20	8.0
512125	513125	FILM 1.5 MIL x 25 " x 500 ' CLEAR	59.05	56.10	53.15	50.20	11.5
512126	513126	FILM 1.5 MIL x 25 " x 1000 ' CLEAR	118.10	112.20	106.30	100.40	23.0
512127	513127	FILM 1.5 MIL x 27 " x 500 ' CLEAR	63.80	60.65	57.45	54.25	12.5
512130	513130	FILM 1.5 MIL x 30 " x 500 ' CLEAR	70.85	67.35	63.80	60.25	13.5
512309	513309	FILM 3 MIL x 9 " x 250 ' CLEAR	24.80	23.60	22.35	21.10	4.0
512312	513312	FILM 3 MIL x 12 " x 250 ' CLEAR	33.05	31.40	29.75	28.10	5.5
512318	513318	FILM 3 MIL x 18 " x 250 ' CLEAR	49.60	47.15	44.65	42.20	8.0
512325	513325	FILM 3 MIL x 25 " x 250 ' CLEAR	49.60	BEST SELLER ONLY 1 PRICE			11.5
512327	513327	FILM 3 MIL x 27 " x 250 ' CLEAR	74.40	70.70	67.00	63.25	12.5
512330	513330	FILM 3 MIL x 30 " x 250 ' CLEAR	82.65	78.55	74.40	70.30	13.5
512509	513509	FILM 5 MIL x 9 " x 200 ' CLEAR	31.20	29.65	28.10	26.55	5.5
512512	513512	FILM 5 MIL x 12 " x 200 ' CLEAR	41.55	39.50	37.40	35.35	7.0
512518	513518	FILM 5 MIL x 18 " x 200 ' CLEAR	62.35	59.25	56.15	53.00	11.0
512525	513525	FILM 5 MIL x 25 " x 200 ' CLEAR	86.55	82.25	77.90	73.60	15.5
512909	513909	FILM 10 MIL x 9 " x 100 ' CLEAR	39.85	37.90	35.90	33.90	5.5
512912	513912	FILM 10 MIL x 12 " x 100 ' CLEAR	53.15	50.50	47.85	45.20	7.0
512918	513918	FILM 10 MIL x 18 " x 100 ' CLEAR	79.70	75.75	71.75	67.75	11.0
512925	513925	FILM 10 MIL x 25 " x 100 ' CLEAR	110.70	105.20	99.65	94.10	15.5
513336	514336	FILM 3 MIL x 36 " x 250 ' CLEAR	99.15	94.20	89.25	84.30	16.5
514109	-	FILM 1.5 MIL x 9 " x 500 ' MAT	95.00	90.25	85.50	80.75	4.0
514112	-	FILM 1.5 MIL x 12 " x 500 ' MAT	126.65	120.35	114.00	107.70	5.5
514118	-	FILM 1.5 MIL x 18 " x 500 ' MAT	190.00	180.50	171.00	161.50	8.0
514125	-	FILM 1.5 MIL x 25 " x 500 ' MAT	263.85	250.70	237.50	224.30	11.5
514312	-	FILM 3 MIL x 12 " x 250 ' MAT	130.80	124.30	117.75	111.20	5.5
514318	-	FILM 3 MIL x 18 " x 250 ' MAT	196.15	186.35	176.55	166.75	8.0
514325	-	FILM 3 MIL x 25 " x 250 ' MAT	272.45	258.85	245.25	231.60	11.5
514327	-	FILM 3 MIL x 27 " x 250 ' MAT	294.25	279.55	264.85	250.15	12.5



Laminating pouches are sold only per box of 100 units.

ITEM	DESCRIPTION	SIZE	THICKNESS	UNIT PRICE							
				100	500	1000	2500	5000	10000	lb/100	
511007	CREDIT	86 x 54 mm - 3 3/8" x 2 1/8"	7 mil.	0.053	0.046	0.043	0.039	0.036	0.032	0.3	
511010	CREDIT	86 x 54 mm - 3 3/8" x 2 1/8"	10 mil.	0.092	0.080	0.074	0.068	0.062	0.055	0.4	
511014	CREDIT	86 x 54 mm - 3 3/8" x 2 1/8"	14 mil.	0.125	0.108	0.100	0.092	0.084	0.075	0.6	
511020	CREDIT	86 x 54 mm - 3 3/8" x 2 1/8"	20 mil.	0.159	0.138	0.128	0.117	0.107	0.096	0.8	
511107	LUGGAGE TAG no slot	108 x 63 mm - 4 1/4" x 2-1/2"	7 mil.	0.079	0.069	0.064	0.058	0.053	0.048	0.4	
511110	LUGGAGE TAG no slot	108 x 63 mm - 4 1/4" x 2-1/2"	10 mil.	0.130	0.113	0.104	0.096	0.087	0.079	0.6	
511114	LUGGAGE TAG no slot	108 x 63 mm - 4 1/4" x 2-1/2"	14 mil.	0.199	0.173	0.160	0.147	0.133	0.120	0.8	
511120	LUGGAGE TAG no slot	108 x 63 mm - 4 1/4" x 2-1/2"	20 mil.	0.272	0.237	0.219	0.201	0.183	0.165	1.1	
511108	LUGGAGE TAG with slot	63 x 108 mm - 2-1/2" x 4 1/4"	7 mil.	0.139	0.129	0.124	0.118	0.113	0.108	0.4	
511111	LUGGAGE TAG with slot	63 x 108 mm - 2-1/2" x 4 1/4"	10 mil.	0.190	0.173	0.164	0.156	0.147	0.139	0.6	
511115	LUGGAGE TAG with slot	63 x 108 mm - 2-1/2" x 4 1/4"	14 mil.	0.259	0.233	0.220	0.207	0.193	0.180	0.8	
511121	LUGGAGE TAG with slot	63 x 108 mm - 2-1/2" x 4 1/4"	20 mil.	0.332	0.297	0.279	0.261	0.243	0.225	1.1	
511207	BUSINESS CARD	95 x 58 mm - 3 3/4" x 2 1/4"	7 mil.	0.059	0.051	0.047	0.044	0.040	0.036	0.4	
511210	BUSINESS CARD	95 x 58 mm - 3 3/4" x 2 1/4"	10 mil.	0.111	0.097	0.089	0.082	0.074	0.067	0.5	
511214	BUSINESS CARD	95 x 58 mm - 3 3/4" x 2 1/4"	14 mil.	0.145	0.126	0.116	0.107	0.097	0.087	0.7	
511220	BUSINESS CARD	95 x 58 mm - 3 3/4" x 2 1/4"	20 mil.	0.200	0.174	0.161	0.147	0.134	0.121	0.9	
511307	MILITARY	99 x 67 mm - 3 7/8" x 2 5/8"	7 mil.	0.071	0.062	0.057	0.052	0.048	0.043	0.4	
511310	MILITARY	99 x 67 mm - 3 7/8" x 2 5/8"	10 mil.	0.114	0.099	0.092	0.084	0.076	0.069	0.6	
511314	MILITARY	99 x 67 mm - 3 7/8" x 2 5/8"	14 mil.	0.179	0.155	0.143	0.132	0.120	0.108	0.8	
511320	MILITARY	99 x 67 mm - 3 7/8" x 2 5/8"	20 mil.	0.232	0.202	0.186	0.171	0.156	0.140	1.1	
511407	I.B.M.	83 x 59 mm - 3 1/4" x 2 5/16"	7 mil.	0.072	0.062	0.058	0.053	0.048	0.043	0.3	
511410	I.B.M.	83 x 59 mm - 3 1/4" x 2 5/16"	10 mil.	0.100	0.087	0.080	0.073	0.067	0.060	0.4	
511414	I.B.M.	83 x 59 mm - 3 1/4" x 2 5/16"	14 mil.	0.131	0.114	0.106	0.097	0.088	0.080	0.6	
511420	I.B.M.	83 x 59 mm - 3 1/4" x 2 5/16"	20 mil.	0.169	0.147	0.136	0.125	0.113	0.102	0.8	
511507	HUNTING & FISHING	140 x 88 mm - 5 1/2" x 3 1/2"	7 mil.	0.133	0.116	0.107	0.098	0.089	0.081	0.7	
511510	HUNTING & FISHING	140 x 88 mm - 5 1/2" x 3 1/2"	10 mil.	0.191	0.166	0.154	0.141	0.128	0.116	1.0	
511514	HUNTING & FISHING	140 x 88 mm - 5 1/2" x 3 1/2"	14 mil.	0.323	0.281	0.259	0.238	0.217	0.195	1.4	
511520	HUNTING & FISHING	140 x 88 mm - 5 1/2" x 3 1/2"	20 mil.	0.506	0.441	0.407	0.373	0.340	0.306	2.0	
511537	POSTAL CARD	102 x 152 mm - 4" x 6"	7 mil.	0.165	0.143	0.132	0.121	0.111	0.100	0.9	
511540	POSTAL CARD	102 x 152 mm - 4" x 6"	10 mil.	0.233	0.202	0.187	0.171	0.156	0.141	1.3	
511544	POSTAL CARD	102 x 152 mm - 4" x 6"	14 mil.	0.371	0.322	0.298	0.273	0.249	0.224	1.8	
511550	POSTAL CARD	102 x 152 mm - 4" x 6"	20 mil.	0.540	0.470	0.434	0.398	0.363	0.327	2.5	
511607	JUMBO	108 x 70 mm - 4 1/4" x 2 3/4"	7 mil.	0.087	0.076	0.070	0.064	0.059	0.053	0.5	
511610	JUMBO	108 x 70 mm - 4 1/4" x 2 3/4"	10 mil.	0.148	0.129	0.119	0.109	0.099	0.090	0.7	
511614	JUMBO	108 x 70 mm - 4 1/4" x 2 3/4"	14 mil.	0.211	0.183	0.169	0.155	0.141	0.127	0.9	
511620	JUMBO	108 x 70 mm - 4 1/4" x 2 3/4"	20 mil.	0.322	0.280	0.259	0.238	0.216	0.195	1.3	
511627	KEY	99 x 64 mm - 3 7/8" - 2 1/2"	7 mil.	0.092	0.080	0.074	0.068	0.062	0.056	0.4	
511630	KEY	99 x 64 mm - 3 7/8" - 2 1/2"	10 mil.	0.114	0.100	0.092	0.084	0.077	0.069	0.6	
511634	KEY	99 x 64 mm - 3 7/8" - 2 1/2"	14 mil.	0.172	0.149	0.138	0.126	0.115	0.104	0.8	
511640	KEY	99 x 64 mm - 3 7/8" - 2 1/2"	20 mil.	0.243	0.211	0.195	0.179	0.163	0.147	1.1	
511647	KING	102 x 76 mm - 4" x 3"	7 mil.	0.097	0.084	0.078	0.071	0.065	0.058	0.5	
511650	KING	102 x 76 mm - 4" x 3"	10 mil.	0.139	0.121	0.112	0.103	0.094	0.084	0.7	
511654	KING	102 x 76 mm - 4" x 3"	14 mil.	0.220	0.192	0.177	0.162	0.148	0.133	0.9	
511660	KING	102 x 76 mm - 4" x 3"	20 mil.	0.291	0.253	0.234	0.214	0.195	0.176	1.3	
511667	PHOTO	152 x 228 mm - 6" x 9"	7 mil.	0.274	0.252	0.241	0.231	0.221	0.211	2.0	
511670	PHOTO	152 x 228 mm - 6" x 9"	10 mil.	0.501	0.461	0.441	0.423	0.404	0.386	2.8	
511674	PHOTO	152 x 228 mm - 6" x 9"	14 mil.	0.693	0.637	0.610	0.585	0.559	0.534	3.9	
511680	PHOTO	152 x 228 mm - 6" x 9"	20 mil.	0.857	0.788	0.755	0.723	0.692	0.660	5.6	



On request Hole, Slot Punching or Rounded corners
On short or long side

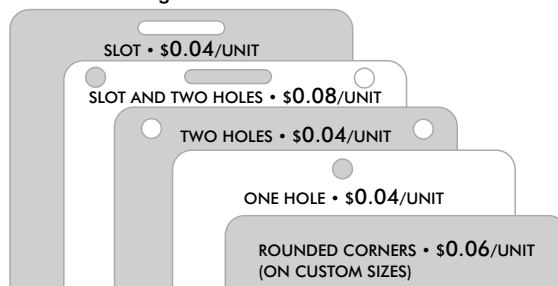

UNIT PRICE

ITEM	DESCRIPTION	SIZE	THICKNESS	100	500	1000	2500	5000	10000	lb/100
511707	LETTER	225 x 290 mm - 8 7/8" x 11 3/8"	7 mil.	0.459	0.422	0.404	0.387	0.370	0.353	3.7
511710	LETTER	225 x 290 mm - 8 7/8" x 11 3/8"	10 mil.	0.800	0.736	0.705	0.675	0.645	0.616	5.2
511714	LETTER	225 x 290 mm - 8 7/8" x 11 3/8"	14 mil.	1.090	1.003	0.960	0.920	0.879	0.839	7.3
511720	LETTER	225 x 290 mm - 8 7/8" x 11 3/8"	20 mil.	1.534	1.411	1.351	1.294	1.238	1.181	10.4
511708	LETTER "MAT"	225 x 290 mm - 8 7/8" x 11 3/8"	7 mil.	0.679	0.624	0.598	0.573	0.548	0.523	3.7
511711	LETTER "MAT"	225 x 290 mm - 8 7/8" x 11 3/8"	10 mil.	1.151	1.059	1.014	0.972	0.929	0.887	5.2
511709	LETTER "SELF ADHESIVE"	225 x 290 mm - 8 7/8" x 11 3/8"	7 mil.	1.323	1.217	1.166	1.117	1.068	1.019	3.7
511712	LETTER "SELF ADHESIVE"	225 x 290 mm - 8 7/8" x 11 3/8"	10 mil.	2.237	2.058	1.971	1.888	1.805	1.722	5.2
511807	LEGAL	225 x 365 mm - 8 7/8" x 14 3/8"	7 mil.	0.576	0.530	0.507	0.486	0.465	0.443	4.6
511810	LEGAL	225 x 365 mm - 8 7/8" x 14 3/8"	10 mil.	1.011	0.930	0.891	0.853	0.816	0.778	6.6
511814	LEGAL	225 x 365 mm - 8 7/8" x 14 3/8"	14 mil.	1.376	1.266	1.212	1.161	1.110	1.060	9.2
511820	LEGAL	225 x 365 mm - 8 7/8" x 14 3/8"	20 mil.	2.175	2.001	1.917	1.836	1.756	1.675	13.1
511808	LEGAL "MAT"	225 x 365 mm - 8 7/8" x 14 3/8"	7 mil.	0.979	0.900	0.862	0.826	0.790	0.754	4.6
511811	LEGAL "MAT"	225 x 365 mm - 8 7/8" x 14 3/8"	10 mil.	1.603	1.474	1.412	1.353	1.293	1.234	6.6
511809	LEGAL "SELF ADHESIVE"	225 x 365 mm - 8 7/8" x 14 3/8"	7 mil.	2.530	2.327	2.229	2.135	2.041	1.948	4.6
511907	MENU	290 x 442 mm - 11 3/8" x 17 3/8"	7 mil.	0.957	0.880	0.843	0.807	0.772	0.737	7.2
511910	MENU	290 x 442 mm - 11 3/8" x 17 3/8"	10 mil.	1.723	1.585	1.518	1.454	1.390	1.327	10.2
511914	MENU	290 x 442 mm - 11 3/8" x 17 3/8"	14 mil.	2.148	1.976	1.892	1.813	1.733	1.654	14.3
511920	MENU	290 x 442 mm - 11 3/8" x 17 3/8"	20 mil.	3.020	2.778	2.661	2.549	2.437	2.325	20.4
511908	MENU "MAT"	290 x 442 mm - 11 3/8" x 17 3/8"	7 mil.	1.493	1.373	1.315	1.260	1.205	1.149	7.2
511911	MENU "MAT"	290 x 442 mm - 11 3/8" x 17 3/8"	10 mil.	2.241	2.062	1.975	1.892	1.809	1.726	10.2
511909	MENU "SELF ADHESIVE"	290 x 442 mm - 11 3/8" x 17 3/8"	7 mil.	2.699	2.483	2.378	2.278	2.178	2.078	7.2
511927	MENU "PLUS"	315 x 468 mm - 12 3/8" x 18 3/8"	7 mil.	1.149	1.057	1.012	0.970	0.927	0.885	8.3
511930	MENU "PLUS"	315 x 468 mm - 12 3/8" x 18 3/8"	10 mil.	1.981	1.823	1.746	1.672	1.599	1.526	11.8

MODEL 325R4 - OFFICE LAMINATOR

Specifications 325R6	ITEM 500325R4
Max. laminating width	12.7" (325 mm)
Max. laminating speed	56"/minute
Max. laminating thickness	20 mil (250 microns)
Heating method	Heated rollers
No. of rollers	4
Carrier	Not required
Temperature control	Yes-electronic
Operating temperature	0-145 C (32-293 F)
Speed control	Yes
Reverse switch	Yes
Pre-heating time	2-3 minutes
Dimensions	18.9" x 8.3" x 4.5"
Weight	21 lb (9.5 kg)
Housing	Metal
Power consumption	550 watts
Price	516.00



ROUNDED CORNERS MACHINE

Included with the machine is the 1/4" size die (R6). Weight: 7 lb

510097 282.00

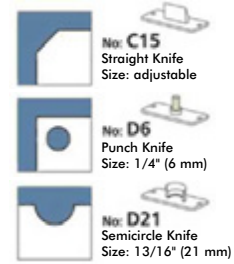
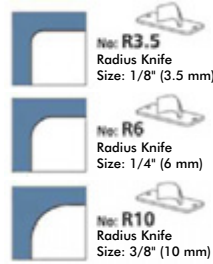

For other shapes, select amongst the 5 optional knives available (1/8", 3/8" and a straight knife). Weight .10 lb

Item	Description	Unit price
510090	Die D6 1/4" - 6 mm hole	35.80
510091	Die R3.5 1/8" - 3.5 mm round	35.80
510092	Die R6 1/4" - 6 mm round	35.80
510093	Die R10 3/8" - 10 mm round	35.80
510094	Die C15 straight knife	35.80
510095	Die D21 13/16" - 21 mm (half round)	52.90



Spare plastic pads

bag of 5 units.
Item: 510096
Price: 8.65

Optional paper guide set for exquisite calendar (sold separately)

Item: 5100976
Price: 58.60



MINI CORNER CUTTER

Mini Corner Cutter for making rounded corners and easy to use & works well on all kinds of sheets, pictures, name cards and laminated cards.

- Radius cut size: (5mm)
- Cutting Capacity: Under 4 sheets
- Blade Material: Stainless Steel

Item: 510021145
Price: 8.65



VERSATILE 3-IN-1 PUNCH

The adjustable knob is easy and quickly converts 3 kinds of functions without a tool.

1. hole paper punch 1/4" hole
2. slot punch for name badge or I.D. card 3 x14 mm
3. Corner cutter 3.5 mm radius cut

Punching capacity 5 sheets of 20 lb paper or 1 acetate sheet

Weight: 1.25 lb
Item: 510100
Price: 41.40

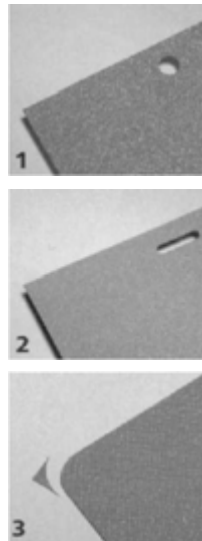

HAND HELD SLOT PUNCH/HEAVY DUTY

Slot size: 1/8" x 1/2"
Weight: 1.25 lb
Item: 510098
Price: 174.30



SLOT PUNCH

With adjustable punching margin 10-15.2 mm

Item: 510059A
Price: 32.85



EURO PUNCH HOLE

25.4 x 7.5 x 4.4 mm
Punching thickness 1.8 mm cardboard 1.5 mm soft PVC or 1.0 mm hard PVC w/adjustable punching margin: 10-15.2mm

Item: 510060A
Price: 32.85



SEMICIRCLE PUNCH

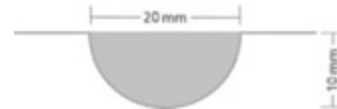

Semicircle size:
Diameter 20mm (13/16")
Punching capacity: max. 8 sheets
Adjustable paper guide

Item: 5100332
Price: 49.35



EFFORTLESS EYELET PUNCH

Table top Eyelet Punch

- With a guide ruler.
- Effortless when making eyelet.
- Punching Capacity: 8 sheets of 80 g./m² paper
- Hole Size: 5mm
- For Ready Eyelet Size: 4.8mm Dia. x 4.6mm length.
- Punching Margin: 10-15.2mm

Weight: 1.25 lb
Item: 5100331
Price: 42.75



HAND HELD EYELET PUNCH

Hole size: 5 mm
Item: 510119
Price: 32.85



EYELETS (GOLD)

Hole size: 5mm
Diameter: 4.8 mm
Length: 4.6 mm
250pcs/plastic box
Item: 510120
Price: 4.05





MANUAL SHREDDER

PEACH DESKTOP MANUAL CROSS CUT SHREDDER

This universal mobile machine is perfect for office and home use, great for shredding paper, CDs and credit cards.

- High quality and durable steel knives
- Level 3 security cross cut

ITEM	50PS300	31.30
------	---------	-------

BINDING RINGS

One of the most popular binding styles, Plastic Comb offers the utmost in flexibility with easy addition or deletion of pages simply by rebinding the book. Plastic Comb Binding elements are available in black and white (please call for details)



	UNIT PRICE														
Capacity	1/4"	5/16"	3/8"	7/16"	1/2"	9/16"	5/8"	3/4"	7/8"	1"	1 1/8"	1 1/4"	1 1/2"	1 3/4"	2"
Sheets	20	40	55	70	90	100	120	150	170	200	220	230	290	360	425
Black	551001	551002	551003	551004	551005	551006	551007	551008	551009	551010	551011	551012	551013	551014	551015
White	552001	552002	552003	552004	552005	552006	552007	552008	552009	552010	552011	552012	552013	552014	552015
Box of	100	100	100	100	100	100	100	100	100	50	50	50	50	50	40
100-900	0.099	0.110	0.119	0.150	0.158	0.202	0.260	0.290	0.352	0.428	0.435	0.533	0.633	0.678	0.729
1000+	0.096	0.106	0.115	0.144	0.152	0.194	0.250	0.279	0.338	0.411	0.418	0.512	0.608	0.651	0.700

*Price for legal (24 rings): Multiply price by 1.4

*Price for (76 rings): Multiply by 4

CLEAR COVER SUPPLIES

Clear protective cover with either rounded or square corners. Other colors of cover available on request.



	UNIT PRICE		
	Clear Cover (square)	Clear Cover (Rounded)	Clear Cover (square)
Format	8 1/2" x 11"	8 3/4" x 11 1/4"	8 1/2" x 14"
Item	550051	550053	550058
100- 900	0.357	0.374	0.501
1000+	0.343	0.360	0.481

SHRINK WRAP MACHINE & FILMS

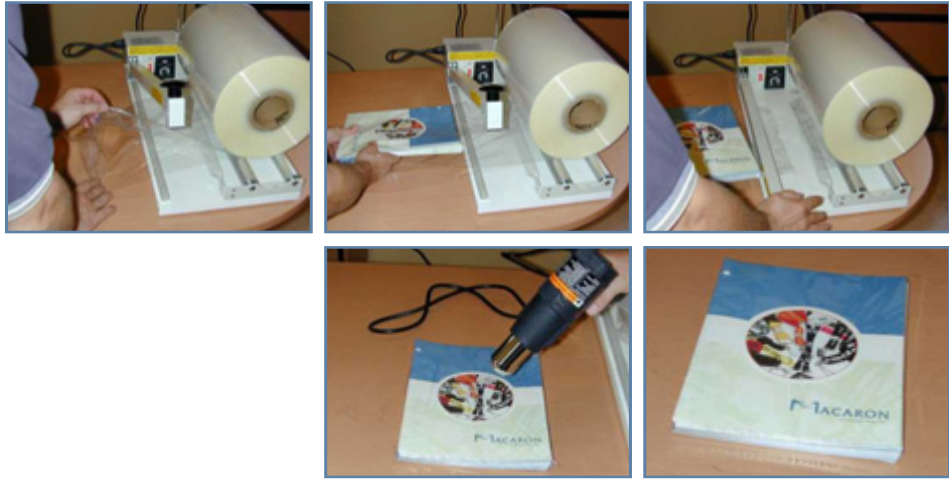

Professional shrink wrap available in 4 different formats, 13, 18, 24 and 32 inches. Protects against dirt, dust, moisture and handling.

- Included with the sealer are :
- Bar sealer with timer
 - Two speed heat gun and holder
 - Film rack
 - One roll of 500 ft
 - Plug outlet
 - Spare parts kit

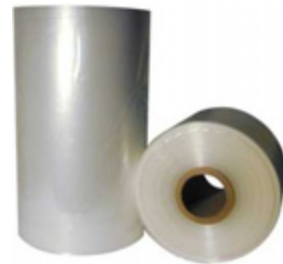

Item	MM-2018	MM-2024	MM-2032
Maximum seal length	18"	24"	32"
Volts	110	110	110
Weight	38 lb	44 lb	49 lb
Item	550018	550024	550032
Price	822.00	940.00	1233.00

Item	Thickness	Width	Price
550113	100G	12"	333.00
550115	100G	14"	387.00
550117	100G	16"	446.00
550119	100G	18"	497.00
550121	100G	20"	554.00
550123	100G	22"	606.00
550125	100G	24"	663.00

HOME STYLE PAPER TRIMMER



5 in 1:



- Straight cut
- Perforation
- Wave cut
- Scoring
- Rounded corner

PAPER CUTTER

A value-priced paper cutter

680GT3



68DSBTM20

Item	Trimmer / Cutter	Weight	Cut	Capacity	Dimension	Price
68DSBTM20	Model TM-20	7 lb	12"	1 sheet	18 1/4" x 8 3/4" x 3 3/8"	71.25
680GT3	Model GT-3	7 lb	17"	8 sheets	14" x 25" x 4"	71.25

ALWAYS
IN STOCK!
CALL US NOW!
READY TO
BE SHIP!

Item	100	250	500	1000	2000	5000
663335, 663336, 663355, 663400, 663401, 663422, 663450, 663455, 664080	0.450	0.420	0.384	0.354	0.324	0.312

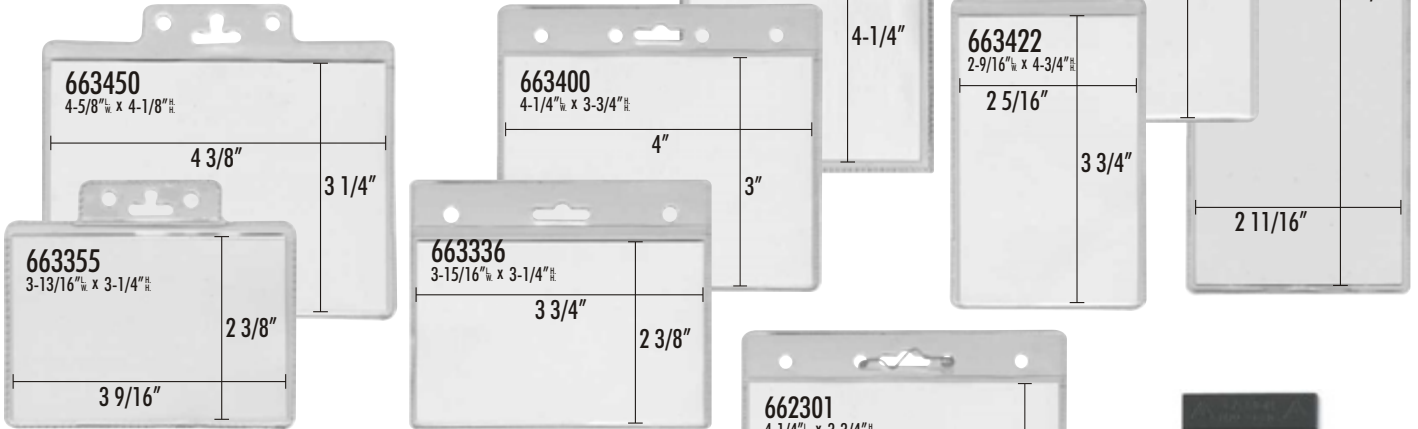

BULL DOG CLIP HOLDER (2300), SAFETY PIN (2301)

Item	100	250	500	1000	2000	5000
662300	1.080	1.020	0.924	0.840	0.780	0.732
662301	0.642	0.600	0.540	0.504	0.462	0.444

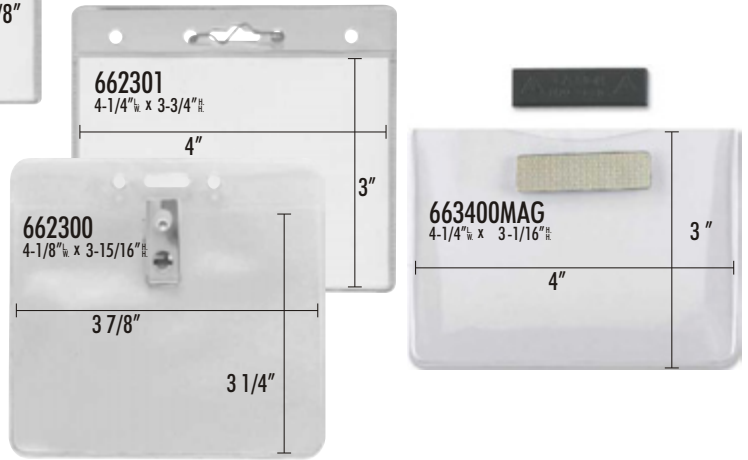

3400MAG (MAGNET BACK)

Item	100	250	500	1000	2000	5000
663400MAG	3.174	2.982	2.694	2.472	2.280	2.160

Clear (00), Black (02), Blue (03), Red (04),
Navy (05), Green (06), Yellow (07)

Item	100	250	500	1000	2000	5000
663555(XX)	0.540	0.510	0.462	0.420	0.390	0.372



INSERTS

Blank inserts (to be used with holder 555, 450, 455)
White(01), Black (02), blue (03), Red(04)
Navy (05), Green (06), Yellow (07)

Item	100	250	500	1000	2000	5000
663556(XX)	0.180	0.174	0.150	0.144	0.132	0.120

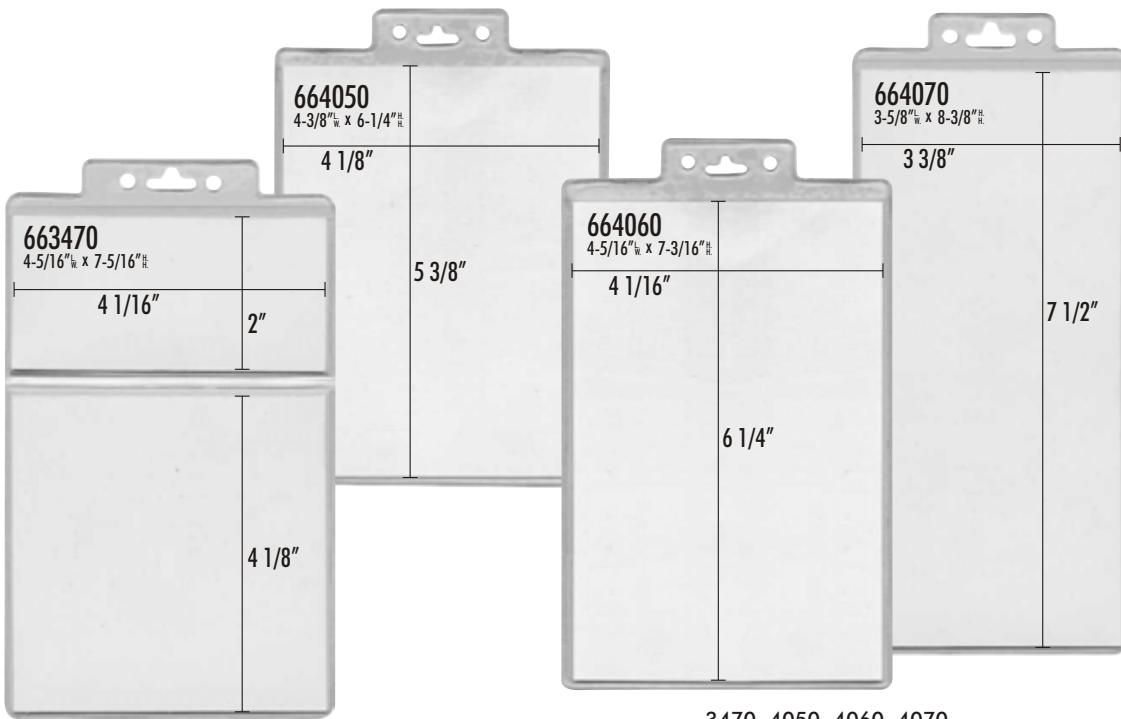

3470, 4050, 4060, 4070

UNIT PRICE

Item	100	250	500	1000	2000	5000
663470, 664050, 664060, 664070	0.714	0.672	0.600	0.552	0.510	0.480

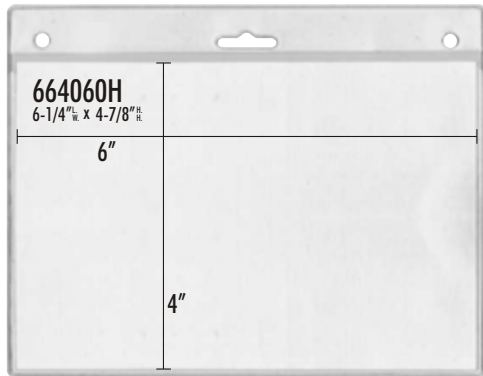

4060H

UNIT PRICE

Item	100	250	500	1000	2000	5000
664060H	0.870	0.822	0.744	0.684	0.630	0.594

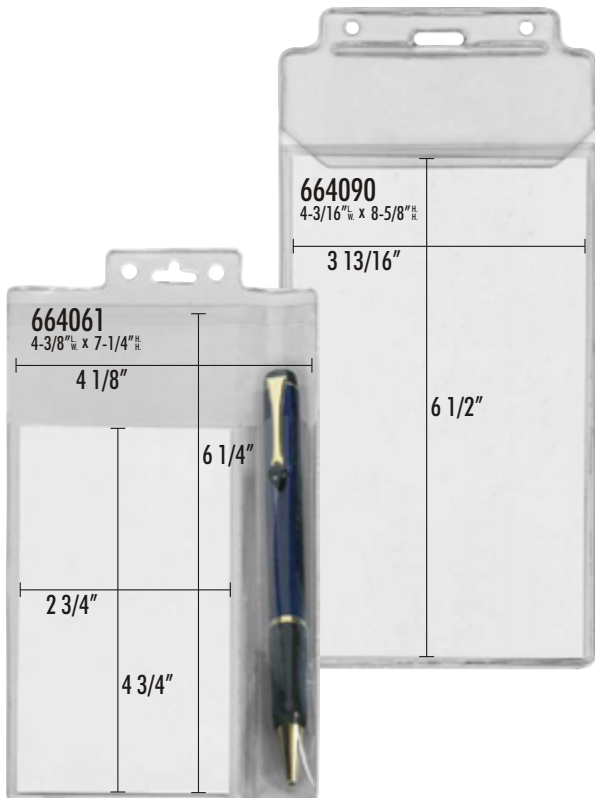

4061, 4090

UNIT PRICE

Item	100	250	500	1000	2000	5000
664061 & 664090	1.050	0.990	0.894	0.822	0.762	0.714

MADE OF CORN BADGE HOLDER (BIODEGRADABLE) UNIT PRICE

Item	100	250	500	1000	2000	5000
66340BIO & 66341BIO	0.702	0.660	0.600	0.552	0.504	0.480

ECO-FRIENDLY BADGE HOLDER UNIT PRICE

Item	100	250	500	1000	2000	5000
66350ECO & 66351ECO	0.774	0.720	0.654	0.600	0.552	0.522

ALL SEASONS HOLDER "ZIP LOCK" CLOSURE UNIT PRICE

Item	100	250	500	1000	2000	5000
665025, 665035	1.080	1.020	0.924	0.840	0.780	0.732
665045	1.362	1.284	1.164	1.062	0.984	0.924

RIGID HOLDER UNIT PRICE

Item	100	250	500	1000	2000	5000
664040, 664041, 664045	1.524	1.434	1.290	1.194	1.092	1.032

RIGID HOLDER ROTATIVE CLIP (BACK)
Clear(00), White (01), Black (02), Blue (03)
Red (04), Green (06), Yellow (07) UNIT PRICE

Item	100	250	500	1000	2000	5000
666060XX	1.272	1.194	1.080	0.990	0.912	0.864



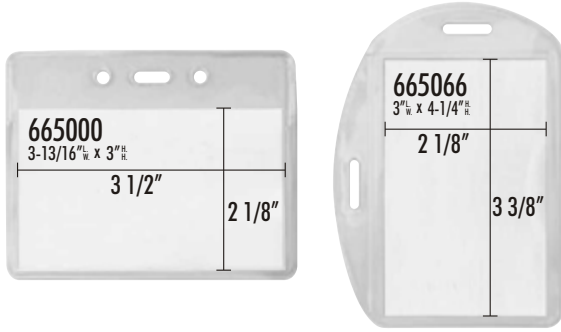

		UNIT PRICE					
Item	5000	100	250	500	1000	2000	5000
665000		0.702	0.660	0.600	0.552	0.504	0.480



		UNIT PRICE					
Item	MULTI-DIRECTIONAL POUCH (5066)	100	250	500	1000	2000	5000
665066		0.702	0.660	0.600	0.552	0.504	0.480

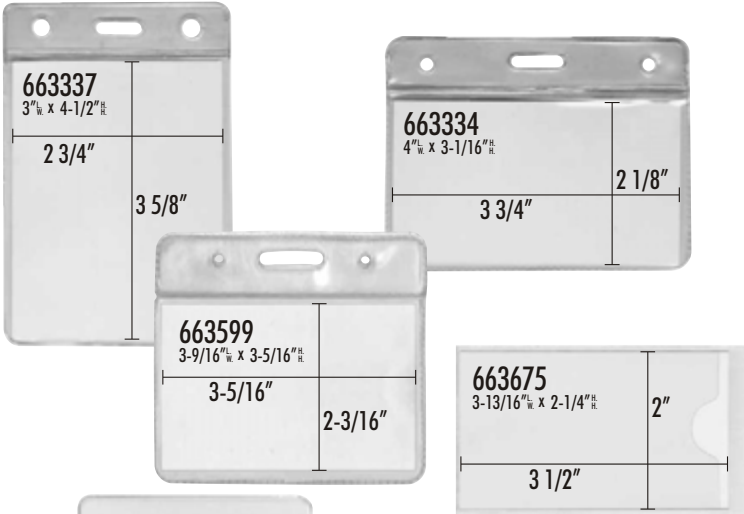

		UNIT PRICE					
Item	3145, 3338 & 5060	100	250	500	1000	2000	5000
663145		0.972	0.912	0.822	0.762	0.702	0.660
663338		1.080	1.020	0.924	0.840	0.780	0.732
665060		0.942	0.882	0.804	0.732	0.684	0.642



		UNIT PRICE					
Item	3334, 3337 (DOUBLE TOP)	100	250	500	1000	2000	5000
663334, 663337 & 663599		1.374	1.290	1.164	1.074	0.990	0.930

		UNIT PRICE					
Item	SELF ADHESIVE CLEAR VINYL, BUSINESS CARD SIZE (3675)	100	250	500	1000	2000	5000
663675		0.714	0.672	0.600	0.552	0.510	0.480

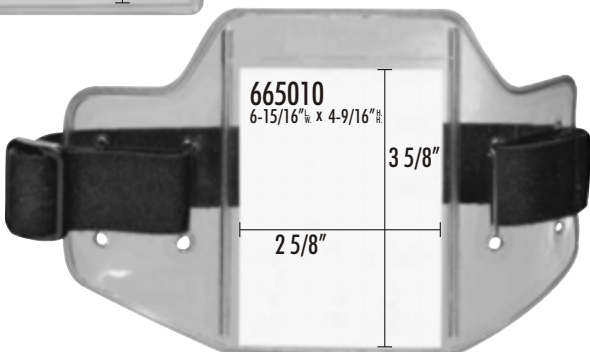

		UNIT PRICE					
Item	PARKING POUCH CLEAR .020" RESISTANT 170°C (5660, 5661)	100	250	500	1000	2000	5000
665660 & 665661		1.314	1.230	1.110	1.020	0.942	0.894

		UNIT PRICE					
Item	ARM BADGE HOLDER	100	250	500	1000	2000	5000
665010		5.640	5.304	4.794	4.404	4.062	3.840

665551



665552



665550



CD Holder	UNIT PRICE					
	100	250	500	1000	2000	5000
665550 Regular	0.804	0.750	0.684	0.624	0.582	0.540
665551 Binder use	0.894	0.840	0.762	0.690	0.642	0.612
665552 Self-adhesive	1.584	1.494	1.344	1.230	1.140	1.074

661710



661711



Protect
your
documents

Vinyl protective pouches	UNIT PRICE					
	100	250	500	1000	2000	5000
661710 8 1/2" x 11" • binder 3 holes	1.890	1.782	1.614	1.470	1.362	1.290
661711 self-adhesive 8 1/2" x 11" (clear front, white back)	2.994	2.814	2.544	2.334	2.154	2.034
661758 self-adhesive 5" x 8" (clear front "copy safe", white back)	1.512	1.422	1.284	1.182	1.092	1.032
661811 self-adhesive 8 1/2" x 14" (clear front, white back)	3.534	3.324	3.000	2.754	2.544	2.400

66253500



Vinyl luggage tag (STRAP SOLD SEPARATELY)
(00) Clear

	UNIT PRICE					
	100	300	500	1000	2500	5000
66253500	0.312	0.294	0.264	0.240	0.222	0.210

621410XX
STRAP SOLD SEPARATELY



Rigid card holder (STRAP SOLD SEPARATELY)
(01) White, (03) Blue, (02) Black, (04) Red

	UNIT PRICE						
	100	300	500	1000	2500	5000	10000
621410XX	1.450	1.380	1.310	1.240	1.160	1.090	1.020

621421XX
STRAP SOLD SEPARATELY

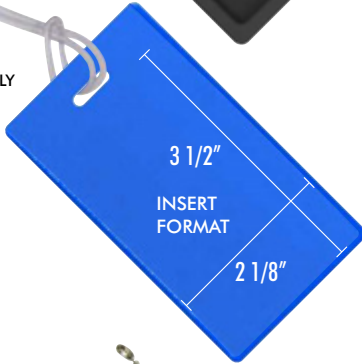

Semi-rigid card holder (STRAP SOLD SEPARATELY)
(01) White, (02) Black, (03) Blue, (04) Red

	UNIT PRICE						
	100	300	500	1000	2500	5000	10000
621421XX	1.350	1.290	1.220	1.150	1.080	1.020	0.950

Beaded Chain 4"

Nickel plated steel ball chain w/connector
Weight : 0.28 lb/100

	UNIT PRICE						
	100	300	500	1000	2500	5000	10000
624004	0.135	0.130	0.125	0.115	0.110	0.105	0.095

6" steel wire with connector

Weight : 0.35 lb/100

	UNIT PRICE						
	100	300	500	1000	2500	5000	10000
624002	0.626	0.595	0.564	0.533	0.501	0.470	0.439

Vinly "T" lock luggage strap 5 7/8"

Weight : 0.46 lb/100 • Clear only

	UNIT PRICE						
	100	300	500	1000	2500	5000	10000
621430	0.295	0.285	0.270	0.255	0.240	0.225	0.210

Genuine leather luggage strap 5" x 1/4"

Gold-tone brass-plated steel buckle (adjustment holes)
(01) White, (02) Black, (43) Tan • Weight : 0.46 lb/100

	UNIT PRICE						
	100	300	500	1000	2500	5000	10000
621041XX	0.530	0.505	0.480	0.455	0.425	0.400	0.375

Plastic luggage strap

304 : (00) Clear, (01) White, (02) Black, (03) Blue, (04) Red, (06) Green
404 : (01) White, (02) Black, (03) Blue, (04) Red

	UNIT PRICE						
	100	300	500	1000	2500	5000	10000
621304XX	0.310	0.295	0.280	0.265	0.250	0.235	0.220
621404XX	0.390	0.375	0.355	0.335	0.315	0.295	0.275

304



404



For trade shows, events, a wide variety of pins and attachments are available to use with vinyl badge holder or laminated cards. Sold in packs of 100 units only.



Bulldog clip with clear PVC strap #602F
1.1 lb/100 UNIT PRICE

	100	300	500	1000	2500	5000	10000
621602	0.430	0.410	0.390	0.370	0.345	0.325	0.305



Suspender clip #002
1.5 lb/100 UNIT PRICE

	100	300	500	1000	2500	5000	10000
621002	0.685	0.655	0.620	0.585	0.550	0.515	0.480



Clear PVC 1-1/4" x 3/16" strap only with snap
0.33 lb/100 UNIT PRICE

	100	300	500	1000	2500	5000	10000
621605	0.460	0.440	0.415	0.395	0.370	0.345	0.325



Bulldog clip #402
0.7 lb/100 UNIT PRICE

	100	300	500	1000	2500	5000	10000
621405	0.295	0.285	0.270	0.255	0.240	0.225	0.210



Bulldog clip #603
0.78 lb/100 UNIT PRICE

	100	300	500	1000	2500	5000	10000
621603	0.295	0.285	0.270	0.255	0.240	0.225	0.210



Bulldog clip (plastic base) #502P
0.9 lb/100 UNIT PRICE

	100	300	500	1000	2500	5000	10000
621503	0.320	0.305	0.290	0.275	0.260	0.240	0.225



Bulldog clip self adhesive #502S
1.3 lb/100 UNIT PRICE

	100	300	500	1000	2500	5000	10000
621502	0.520	0.495	0.470	0.445	0.420	0.390	0.365



Plastic connector (double split ring not included)
0.08 lb/100 UNIT PRICE

	100	300	500	1000	2500	5000	10000
62635000	0.124	0.118	0.112	0.106	0.100	0.093	0.087



Brass safety pin 3/4"
0.04 lb/100 UNIT PRICE

	100	300	500	1000	2500	5000	10000
622001	0.069	0.066	0.063	0.059	0.056	0.052	0.049



Steel crimp pin 1" #111
0.15 lb/100 UNIT PRICE

	100	300	500	1000	2500	5000	10000
622111	0.057	0.055	0.052	0.049	0.046	0.043	0.040

Steel crimp pin 1-1/4" #211
0.18 lb/100 UNIT PRICE

	100	300	500	1000	2500	5000	10000
622211	0.057	0.055	0.052	0.049	0.046	0.043	0.040



Bar pin #211P - plastic base 1-1/2" x 5/16"
0.23 lb/100 UNIT PRICE

	100	300	500	1000	2500	5000	10000
621211	0.275	0.265	0.250	0.235	0.220	0.210	0.195



Bar pin #211S - self adhesive base 1-1/2" x 5/16"
0.25 lb/100 UNIT PRICE

	100	300	500	1000	2500	5000	10000
621212	0.390	0.375	0.355	0.335	0.315	0.295	0.275



Bar pin #301D steel base 1-1/2" x 3/16"
0.35 lb/100 UNIT PRICE

	100	300	500	1000	2500	5000	10000
621301	0.295	0.285	0.270	0.255	0.240	0.225	0.210



Bar pin #301P plastic base 1-5/8" x 3/8"
0.4 lb/100 UNIT PRICE

	100	300	500	1000	2500	5000	10000
621302	0.330	0.315	0.300	0.285	0.265	0.250	0.235



Bar pin #401P plastic base 1-3/8" x 3/8"
0.44 lb/100 UNIT PRICE

	100	300	500	1000	2500	5000	10000
621402	0.325	0.310	0.295	0.280	0.260	0.245	0.230



Bar pin #301S self adhesive base 1-5/8" x 3/8"
0.45 lb/100 UNIT PRICE

	100	300	500	1000	2500	5000	10000
621303	0.560	0.535	0.505	0.480	0.450	0.420	0.395



"GRIPPER" for identity card without hole nor slot, 11/16" x 1"
0.001 lb/100 UNIT PRICE

	100	300	500	1000	2500	5000	10000
621608	1.290	1.230	1.165	1.100	1.035	0.970	0.905

RINGS & BINDER RINGS



Item		UNIT PRICE								Weight/100
		100	300	500	1000	2500	5000	10000		
624006	Split ring nickel 6mm - 1/4"	0.018	0.018	0.017	0.016	0.015	0.014	0.013	0.07 lb	
624010	Triangle nickel 10mm - 3/8"	0.034	0.033	0.031	0.029	0.028	0.026	0.024	0.162 lb	
624015	Double split ring 15mm - nickel - 9/16"	0.040	0.038	0.036	0.034	0.032	0.030	0.028	0.35 lb	
624016	Double split ring 15mm - gold - 9/16"	0.041	0.039	0.037	0.035	0.033	0.031	0.029	0.35 lb	
624020	Double split ring 20mm - nickel - 3/4"	0.041	0.039	0.037	0.035	0.033	0.031	0.029	0.45 lb	
624021	Double split ring 20mm - gold - 3/4"	0.043	0.041	0.039	0.037	0.035	0.033	0.031	0.45 lb	
624025	Double split ring 25mm - nickel - 1"	0.047	0.045	0.043	0.040	0.038	0.036	0.033	0.55 lb	
624026	Double split ring 25mm - gold - 1"	0.050	0.048	0.045	0.043	0.040	0.038	0.035	0.55 lb	
624033	Double split ring 33mm - nickel - 1 1/4"	0.075	0.072	0.068	0.064	0.060	0.057	0.053	1.15 lb	
624034	Double split ring 33mm - gold - 1 1/4"	0.083	0.079	0.075	0.071	0.067	0.063	0.059	1.15 lb	
624020BR	Binder ring 20mm - nickel - 3/4"	0.186	0.177	0.168	0.159	0.149	0.140	0.131	1.10 lb	
624025BR	Binder ring 25mm - nickel - 1"	0.200	0.190	0.180	0.170	0.160	0.150	0.140	1.80 lb	
624050BR	Binder ring 50mm - nickel - 2"	0.287	0.273	0.259	0.244	0.230	0.216	0.201	2.50 lb	
624076BR	Binder ring 76mm - nickel - 3"	0.751	0.714	0.676	0.639	0.601	0.564	0.526	6.50 lb	
624025D	2 split ring 25mm - 1" with detachable	2.900	2.755	2.610	2.465	2.320	2.175	2.030	3.90 lb	



CARABINERS

3" Flat side

Colors: black (02), blue (03), red (04), green (06), silver (20)

Webbing strap: 3/4" x 2 3/8"

Silver plate: 1 1/8" x 1 1/16"

NOT FOR CLIMBING PURPOSES.



Item		UNIT PRICE							Weight/100
		100	300	500	1000	2500	5000	10000	
760CARXX	Carabiner only	1.300	1.240	1.170	1.110	1.040	0.980	0.910	1.3 lb
765CARXX	Carabiner with strap & double split ring 33mm	2.030	1.930	1.830	1.730	1.630	1.530	1.430	2.6 lb
766CAR	Carabiner with strap & bottle holder	2.320	2.210	2.090	1.980	1.860	1.740	1.630	8.75 lb

623441



623443



623448



BADGE MAGNETS

Item		UNIT PRICE							Weight/100
		10	100	300	500	1000	2500	5000	
623441	Simple magnet with metal and self adhesive 5/8" round	1.043	0.904	0.800	0.695	0.637	0.580	0.522	1.1 lb
623443	Double magnet with metal and self adhesive 1/2" x 1-5/16"	1.391	1.206	1.066	0.927	0.850	0.773	0.696	1.8 lb
623448	Triple magnet with metal and self adhesive 1/2" x 1-3/4"	1.461	1.266	1.120	0.974	0.893	0.812	0.731	2.4 lb

MM400: Ultra light-ideal for use shirts & blouse



MM405: Powerful, over 400gr pull



MM406: Maximum control for heaviest fabrics



Magnabadge strong no vinyl



BADGE MAGNETS

The badge magnets MM400-405 and 406 have a unique form and a finish that totally seals the magnet and protects clothing.

Item		UNIT PRICE							Weight/100
		10	100	300	500	1000	2500	5000	
623401	MM400 (magnet, steel plate and double face tape)	2.140	2.040	1.930	1.820	1.720	1.610	1.500	2.5 lb
623405	MM405 (strong magnet, steel plate and double face tape)	3.290	3.130	2.970	2.800	2.640	2.470	2.310	2.75 lb
623406	MM406 (2 magnets and double face tape)	4.200	3.990	3.780	3.570	3.360	3.150	2.940	3.25 lb
623408	MAGNABADGE *strong no vinyl*	2.970	2.830	2.680	2.530	2.380	2.230	2.080	4 lb

Lanyards are made of polyester.
 Tubular or standard fabric
 5 available stock colors
 Available width: 3/8", 1/2" and 3/4"
 Packaging: bundle of 25 units

VISIT
www.promomacaron.ca
 FOR ALL OUR
 PROMOTIONAL PRODUCTS



Available stock colors

(01) White • (02) Black • (03) Blue • (04) Red • (05) Navy

BASIC PRICE INCLUDES ONE OF THESE ATTACHMENTS:

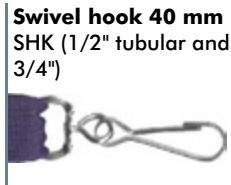
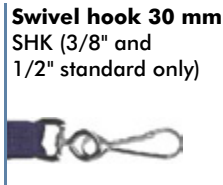

For printed lanyards, give us a call!

ITEM	100	250	500	1000
3/8" (378 tub)	1.044	0.924	0.804	0.678
1/2" (503 tub)	1.182	1.044	0.906	0.768
3/4" (753 tub)	1.308	1.158	1.002	0.852



"SAVING OPTION" LANYARDS

(5-7 working days)

Lanyards are made of polyester, tubular fabric
 Available width: 3/8"
 Available in 5 colors: White (01), Black (02), Royal blue (03), Red (04), Navy (05)
 Packaging: bundle of 25 units

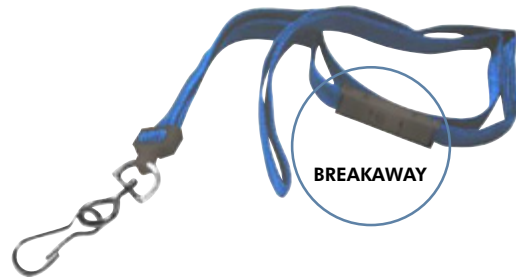

Item	100	250	500	1000
OS377XX	1.122	1.002	0.882	0.762

ECONO LANYARDS

Polyester cord style 1/8" non printed
 Available in 5 colors:
 White (01), Black (02), Royal Blue (03), Red (04), Navy (05)
 Packaging: bundle of 25 units

BASIC PRICE INCLUDES ONE OF THESE ATTACHMENTS:



Item	100	250	500	1000
125	1.080	0.954	0.828	0.702



STOCK
PRODUCTS!
READY
TO SHIP

2024

Nylon string 36"
Available in white only

	UNIT PRICE						
	100	250	500	1000	2000	5000	10000
621006	0.240	0.234	0.222	0.210	0.204	0.180	0.174



Plastic beaded neck chain 38"
Available colors: clear (00), white (01), black (02),
blue (03), red (04), navy (05) and green (06)

	UNIT PRICE						
	100	250	500	1000	2000	5000	10000
621038XX	1.332	1.272	1.200	1.140	1.074	1.002	0.942

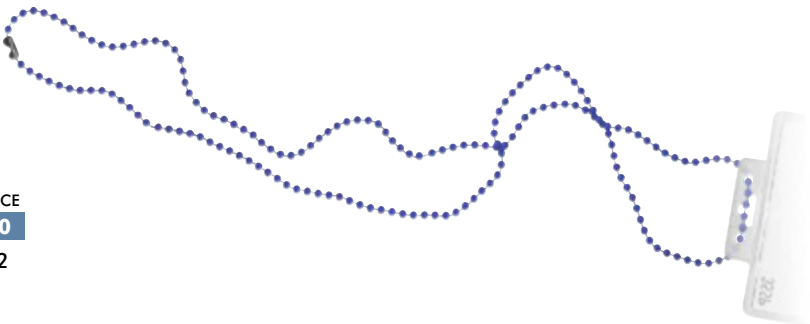

Nickel-Plated Beaded Neck Chain (No. 3, 2.3 mm bead)
Available in 2 lengths:

	UNIT PRICE						
	100	250	500	1000	2000	5000	10000
Item 621004 • 30"	0.912	0.870	0.822	0.780	0.732	0.690	0.642
Item 621005 • 36"	1.044	0.990	0.942	0.894	0.840	0.780	0.732



Polyester cord style 1/8" • no attachments
Available in 5 colors:

	UNIT PRICE						
	100	250	500	1000	2000	5000	10000
(01) White (03) Royal blue (05) Navy	0.444	0.420	0.402	0.384	0.360	0.330	0.312
(02) Black (04) Red							



Elastic string with metallic ends 30"
Available colors:
white (01), black (02), grey (08)

	UNIT PRICE						
	100	250	500	1000	2000	5000	10000
621031XX	0.390	0.384	0.360	0.342	0.324	0.300	0.282

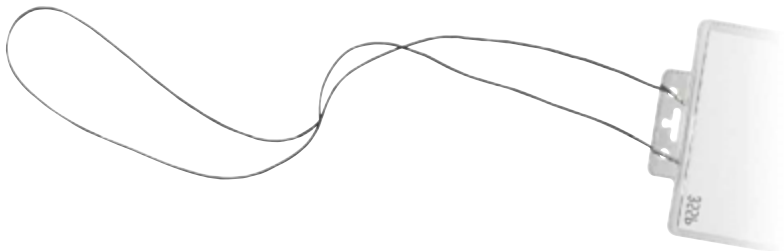

Badge holders NOT INCLUDED

Chains & Cords



STANDARD BADGE REEL

Solid or Translucent Plastic Clip on
 Reel diameter: 1 1/4"
 Cord length: 30"
 Imprint area: 5/8"

Solid Color 621680XX, 621690XX
 (01) White • (02) Black • (03) Blue • (04) Red • (08) Grey
 Translucent Color 621670XX
 (00) Clear • (03) Blue • (04) Red • (06) Green

Item	100	250	500	1000	2000	5000
621670XX & 621690XX	1.572	1.422	1.380	1.344	1.302	1.260

UNIT PRICE



MEGA BADGE REEL

Reel diameter: 1 3/8"
 Cord length: 36"
 Imprint area: 1 3/16"
 (01) White • (02) Black • (03) Blue • (08) Grey

Item	100	250	500	1000	2000	5000
621695XX	1.752	1.584	1.500	1.422	1.332	1.254

UNIT PRICE



HEAVY DUTY BADGE REEL

621700, 621700A 62172020
 Reel diameter: 1 1/2" Reel diameter: 1"
 Cord length: 29 1/2" Cord length: 29 1/2"

Item	100	250	500	1000	2000	5000
621700 Nylon wire	5.724	4.644	4.500	4.350	4.212	4.062
621700A Steel wire	6.522	5.442	5.304	5.154	5.010	4.860
62172020	3.594	2.922	2.784	2.652	2.520	2.382

UNIT PRICE



"CARABINER" STYLE

Solid color
 Reel diameter: 1 1/4"
 Cord length: 25"

Solid Color 621800XX,
 62171102 in black only
 (01) White • (02) Black • (03) Blue • (04) Red

Item	100	250	500	1000	2000	5000
621800XX & 62171102	4.044	3.282	3.132	2.982	2.832	2.682

UNIT PRICE



TYVEK 3/4"

Item	100	500	1000
624100XX	0.282	0.180	0.174

UNIT PRICE



THIN PLASTIC

Item	100	500	1000
624225XX	N/A	0.882	0.528

UNIT PRICE



VINYL WIDE FACE

Item	100	500	1000
624300XX	N/A	0.882	0.528

UNIT PRICE

Available colors (01) White • (02) Black • (03) Blue • (04) Red • (06) Forest Green
 (07) Yellow • (08) Grey • (11) Purple • (14) Aqua • (15) Light Blue • (17) Neon Lime
 (18) Neon Orange • (19) Neon Pink • (21) Yellow Glow • (22) Sunfire • (23) Gold

Ideal for Events!

FOR CUSTOM PRINT,
 GIVE US A CALL
 FOR PRICING

VISIT
www.promomacaron.ca
 FOR ALL OUR
 PROMOTIONAL PRODUCTS

NON TRANSFERABLE
 Single use,
 resistant and
 waterproof.

Model 350
ECONOMY TRIMMERS

Lightweight and portable. Value-priced-comes with its own cutting matt.

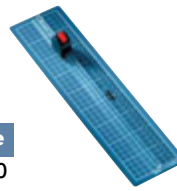

Item	Hobby trimmers	Weight	Cut	Capacity	Dimension	Price
680350	Model 350	2 lb	13"	4 sheets	15" x 4"	57.00

Model 370

Great for card making & scrapbooking. Includes 3 cutting heads: straight, deckle and scoring and self healing cutting mat. Free-floating ruler cuts edges or interior holes.

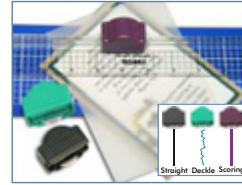

Item	Hobby trimmers	Weight	Cut	Capacity	Dimension	Price
680370	Model 370	2 lb	13"	3 sheets	15" x 4"	72.00

Model 500/507/508

HOBBY TRIMMERS

Precise cutting – simple operation. For fast and accurate trimming of paper, photos or film in hobby or general office environments.

- Ground circular blade enclosed in plastic housing cuts in either direction (self-sharpening and replaceable)
- Rubber wheel holds down plastic guard prevents paper from moving
- Standard grid preprinted on metal base
- Scale bars



Model 507K sold with straight, wavy, deckle and perforation cutting heads

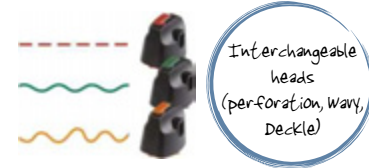

Interchangeable heads (perforation, wavy, deckle)

Interchangeable heads now allow choice of straight, perforated, wavy or deckle cuts. Weight: .5 lb/head

Item	Hobby trimmers	Weight	Cut	Capacity	Dimension	Price
680507	Model 507	4 lb	12 1/2"	5 sheets	17" x 8 1/4"	174.00
680507K	Model 507K (4 cutting heads)	5 lb	12 1/2"	5 sheets	17" x 8 1/4"	240.00
680508	Model 508	6 lb	18"	5 sheets	22 1/2" x 8 1/4"	234.00

Item	Model	Price
680961	Perforated Cutting head 970-P	58.00
680962	Wavy Cutting Head/970-W	58.00
680963	Deckle cutting head/970Z	58.00
680960	(Perforated, Wavy and Deckle) heads	30.00
680965	Plastic cutting strip #507	22.00
680966	Plastic cutting strip #508	25.00
680970	Straight cutting head	64.00

Model 403/404

HOBBY CUTTERS

Useful anywhere where quick, safe and accurate cutting is needed.

- Polyboard resin base with integrated guidelines
- Upper and lower blades made of Solingen Steel with transparent fan guard to protect fingers
- Upper blade will not fly up or drop down
- Scale bar and adjustable backstop



Item	Hobby Trimmer	Weight	Cut	Capacity	Dimension	Price
680403	Model 403	6 lb	12"	10 sheets	16 1/2" x 9 1/4"	253.00
680404	Model 404	7 lb	18"	10 sheets	21 1/2" x 9 1/4"	443.00

Model 012/015/018

VANTAGE TRIMMER

Precision trimmer safe and easy to use as well as affordable.

- Spring action, metal blade
- Automatic paper clamp
- Non skid rubber feet
- Metal base

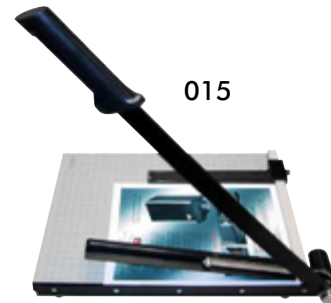

Item	Vantage Trimmer	Weight	Cut	Capacity	Price
680012	Model 012	7 lb	12"	15 sheets	128.00
680015	Model 015	9 lb	15"	15 sheets	145.00
680018	Model 018	11 lb	18"	15 sheets	190.00



Model 533/534

PRECISION GUILLOTINES

High performance, value priced.

- Precision cutting of up to 15 sheets
- Upper and lower blades made of Solingen Steel – will not fly up or drop down
- Hand clamp with finger guard
- Standard formats preprinted on metal base
- Scale bar and adjustable backstop

Item	Precision guillotines	Weight	Cut	Capacity	Dimension	Price
680533	Model 533	8 lb	12"	15 sheets	16 1/2" x 11"	312.00
680534	Model 534	10 lb	18"	15 sheets	21 1/2" x 11"	425.00

Model 550/552/554/556/558

ROTARY TRIMMERS

Professional use in graphic design and photographic studios.

- Ground circular blade enclosed in plastic housing cuts in both directions (replaceable and self-sharpening)
- Automatic clamp and adjustable back stop
- Preprinted grid lines on models 550-552-554
- Can be wall mounted-optional paper roll holder available
- 556 & 558 have optional floor stands



550

Item	Trimmers	Weight	Cut	Capacity	Dimension	Price
680550	Model 550	7 lb	14 1/8"	10 sheets	21 3/4" x 12 1/2"	337.00
680552	Model 552	8 lb	20 1/8"	10 sheets	25 3/4" x 12 1/2"	420.00
680554	Model 554	10 lb	28 1/4"	10 sheets	36" x 12 1/2"	518.00
680556	Model 556	13 lb	37 1/2"	8 sheets	45 1/2" x 12 1/2"	686.00
680558	Model 558	16 lb	51"	6 sheets	58 3/4" x 12 1/2"	892.00

Optional stand

Item	Stands	Price
680696	696 to be use with model 556	625.00
680698	698 to be use with model 558	824.00



Stand sold separately.

Model 440/442/444/446/448

PREMIUM TRIMMERS

High capacity trimmer that cuts up to 30 sheets of paper at once (model 440,442)

- Metal base with pre-printed guides for precise cuts
- Self sharpening blade cuts in either direction
- Ground circular blade enclosed in plastic housing
- Automatic see through paper clamp
- Thick-walled aluminium guide rod
- Adjustable backstop that fits on either side
- Can be wall mounted



444

Item	Trimmers	Weight	Cut	Capacity	Dimension	Price
680440	440	13 lb	14 7/8"	30 sheets	22" x 15 1/8"	539.00
680442	442	15 lb	20 1/8"	30 sheets	28" x 15 1/8"	753.00
680444	444	18 lb	26 3/8"	25 sheets	34 1/8" x 15 1/8"	1003.00
680446	446	23 lb	36 1/4"	22 sheets	44 1/8 x 15 1/8"	1320.00
680448	448	30 lb	51 1/8"	20 sheets	59" x 15 1/8"	1531.00

Possibility to add a stand.

Item	Stands	Price
680796	To be use with model 446	671.00
680798	To be use with model 448	884.00



796



Model 561/565
SAFETY FIRST GUILLOTINES – OFFICE

Rotary guard covers the blade throughout the entire cutting process - the ULTIMATE safety device.

- Metal base cutters with pre-printed guidelines
- Ground upper and lower blades made of Solingen Steel
- Adjustable back stop
- Automatic clamp
- 565 has stripcut mechanism for trimming continuous stationery, and extendable front stop
- Cuts up to 30 sheets

Item	Guillotines	Weight	Cut	Capacity	Dimension	Price
680561	Model 561	15 lb	14 1/2"	30 sheets	17 1/4" x 10 1/2"	808.00
680565	Model 565	21 lb	15 1/2"	30 sheets	18 3/4" x 14"	1264.00

Model 564
SAFETY FIRST GUILLOTINES – LASER GUIDE

- Laser guided line will show exactly where the cut will be
- Rotary guard covers the blade for maximum safety
- Ratcheting paper clamp will lock the material in place until it is manually released
- Ground self-sharpening blade made of Solingen Steel
- Sturdy blade will not fly up or drop down unexpectedly
- Rotary guard covers the blade throughout the entire cutting process
- Adjustable backstop
- Cuts up to 40 sheets of paper at a time



Item	Safety first guillotines	Weight	Cut	Capacity	Dimension	Price
680564	Model 564	15 lb	14 1/2"	40 sheets	17 1/4" x 10 1/2"	1392.00



Model 567/569
SAFETY FIRST GUILLOTINES COMMERCIAL

Lockable guillotine with rotary guard covers the blade throughout the entire cutting process.

- Extendable front-stop to 8 1/4"
- Metal base cutters with pre-printed guidelines
- Ground upper and lower blades made of Solingen Steel
- Adjustable back stop
- Adjustable hand clamp
- Strip cut mechanism
- Cuts up to 30 sheets

Item	Safety first guillotines	Weight	Cut	Capacity	Dimension	Price
680567	Model 567	34 lb	21 1/2"	30 sheets	23 1/2" x 14 1/4"	2286.00
680569	Model 569	54 lb	27 1/2"	30 sheets	29 1/2" x 21 1/2"	3858.00



DAHLE OFFICE MAGNETS

Dahle magnets are round 1 1/2". They will cling to any surface with a reasonable ferrous content. Color available: black (02), blue (03), red (04) and yellow (07). Sold in box of 10 units.



Item	Magnets	Weight/10	Unit price
6855(xx)	Round (heavy duty) – 1 1/2"	1.51 lb	5.75

DAHLE VANTAGE CUTTING MATS

- Self-healing properties allow for maximum durability
- 1/8" thickness protects work surfaces from being damaged
- Surface material protects blade from becoming dull
- Pre-printed grid for easy sizing of paper
- Available in blue and translucent.



Item	Cutting mats	Dimension	Price
680680	Translucent	9" x12"	25.00
680681	Translucent	12" x 18"	46.00
680682	Translucent	18" x 24"	90.00
680683	Translucent	24" x 36"	135.00
680694	Blue	36" x 48"	225.00

Model 912/1218/1824/2436

MACARON CUTTING MATS

Self-sealing cutting mats preserve your work surface.

- Triple-layered construction
- Self-healing cutting surface
- Blade-resistant core
- Preprinted guidelines on one side; other side blank



Item	Cutting mats	Dimension	Price
680912	Model 912	9" x12"	20.00
681218	Model 1218	12" x 18"	32.00
681824	Model 1824	18" x 24"	55.00
682436	Model 2436	24" x 36"	87.00

Model 73336 / 73342

SAFETY EDGE

Unique tool for protecting hands from tough cuts.

- Tough aluminum edge for accident-free jobs
- Non-skid rubber facing prevents slips
- Precision graduated edge makes it perfect of both ruling pens and knife blades
- Easy-to-hold, rigid lip
- Hangs for storage

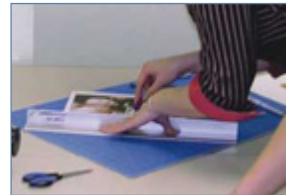

Item	Safety Edge	Dimension	Price
683336	Model 73336	36"	219.00
683342	Model 73342	42"	241.00

VANTAGE SCISSORS



SUPER SHEARS



SCISSORS

Item		Unit price
6840006	SCISSOR DAHLE VANTAGE # 40006	7.75
6840008	SCISSOR DAHLE VANTAGE # 40008	9.35
6850008	SUPER SHEAR DAHLE 8" # 50008	61.95



HOT STAMPING PRESSES

Hot stamping presses are easy to use to print on small or large items. Print metallic or matt foils on leather, plastic, cardboard paper, stickers, vinyl and wood. Does not require drying time. Three air operated presses are available (MM-2, MM-5, MM-9).

TECHNICAL SPECIFICATIONS

Press Model	MM-2	MM-5	MM-9
Max.	4 000 lb	11 000 lb	18 000 lb
Pressure	2 000 kg	5 000 kg	8 000 kg
Printing Area	5" x 7"	8" x 10 1/2"	10 1/2" x 16"
Clearance between type and table	1 3/4"	3"	3"
Maximum opening	12" high	12" high	12" high
Size of working table	11" x 15"	15" x 18"	19" x 25"
Weight	308 lb	795 lb	1550 lb
Power Source	110 V	220 V	220 V
Power Consumption	400 W	1 200 W	3 600 W
Production Capacity	Between 500 and 1500 impressions per hour	Between 500 and 1500 impressions per hour	Between 500 and 750 impressions per hour
Item	461020	461050	461090
Price	\$ 9830.00	\$ 15916.00	On request

MM-2



MM-5



MM-9



FOILS

METALLIC FOILS

Item	Color
475009	Silver
475018	Blue
475027	Copper
475039	Black
475045	Gold
475054	Pink
475060	Red
475066	Green
475069	Violet

MATT FOILS

Item	Color
475001	Aqua
475003	Silver
475012	White
475015	Blue
475030	Grey
475036	Black
475042	Gold
475057	Red
475063	Green



Foil is available in 16 colors metallic and/or matt. Foils come in 600' long, and will be cut as requested. Price is based per inch x 600' long.
(example: one roll of 3" = 3 x 8.95 = 26.85)

Metallic and matt foils		Price/inch x 600'	
1" - 10"	11" - 23"	24" - 47"	48" +
11.40	10.00	8.55	8.00

2024

equipments
and supplies



MACARON
www.macaron.ca

VISIT
www.promomacaron.ca
FOR ALL OUR
PROMOTIONAL PRODUCTS

8639, 8th Avenue
Montreal, Quebec, Canada
H1Z 2X4
Tel.: 514-721-5221, 1-800-350-4383
Fax: 514-722-7099, 1-800-465-6424
email: macaron@macaron.ca
site: www.macaron.ca